

Multi-channel flat fan nozzles for air "Whisperblast", plastic version Series 600.484.56

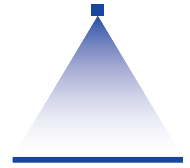

Features:

- Compact, powerful air stream
- Low noise level (also at higher levels of pressure)
- Narrow design

Applications:

- Blowing off and out
- Cleaning
- Drying
- Cooling
- Transporting

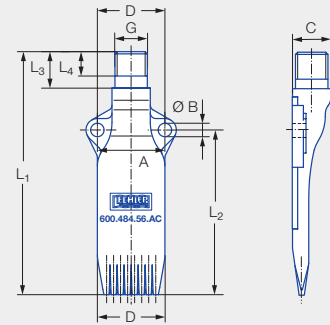

Series 600.484.56

¹ Meets OSHA specifications in terms of noise level.

Cost savings and noise reduction



Cost savings

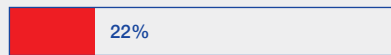

Noise reduction

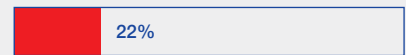

Technical data

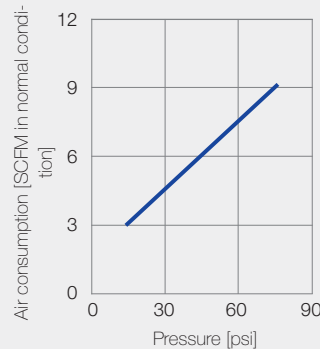
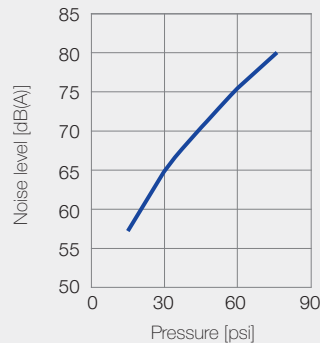
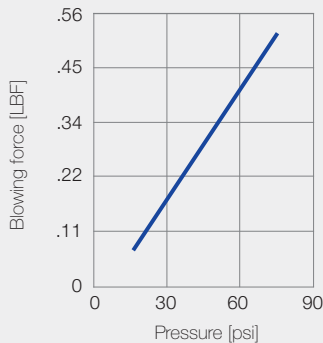

| Connection | G | Dimensions [in] | | | | | | | | Weight [lbs] |
|------------|-------------------------------|-----------------|------|------|----------------|----------------|----------------|----------------|------|--------------|
| | | A | C | D | L ₁ | L ₂ | L ₃ | L ₄ | Ø B | |
| AC | 1/4 BSPP | 0.98 | 0.56 | 0.98 | 3.54 | 2.40 | 0.53 | 0.35 | 0.20 | 0.04 |
| BC | 1/4 NPT | 0.98 | 0.56 | 0.98 | 3.54 | 2.40 | 0.53 | 0.35 | 0.20 | 0.04 |
| HG | M12 x 1.25 | 0.98 | 0.56 | 0.98 | 3.54 | 2.40 | 0.53 | 0.35 | 0.20 | 0.04 |
| 00 | Quick-release coupling size 5 | 0.98 | 0.56 | 0.98 | 3.54 | 2.40 | 0.53 | - | 0.20 | 0.04 |

| Ordering number | | | | | |
|-----------------|-----------------|------------|---------|------------|-------------------------------|
| Type | Material number | Connection | | | |
| | 56 | 1/4 BSPP | 1/4 NPT | M12 x 1.25 | Quick-release coupling size 5 |
| 600.484 | ● | AC | BC | HG | 00 |

Ordering Type + Material no. + Code = Ordering no.
example: 600.484 + 56 + BC = 600.484.56.BC



Assembly accessories can be found in Chapter 12 "Accessories".